



XOU24BWDDGO

24" PANEL READY COMBO BEVERAGE
CENTER & WINE COOLER

PANEL READY UNDERCOUNTER REFRIGERATION



XOU24BWDDGO

- Extending Glass Shelves & Racks
- Tri-Color Interior LED Lighting
- Intuitive Digital Touch Controls for Two Temperature Zones

24" UNDERCOUNTER COMBO UNIT with OVERLAY FRAME DOORS

THE ULTIMATE IN CONVENIENT ENTERTAINING -YOUR FAVORITE VINTAGES AND ICY COLD BEVERAGES READY TO SERVE, JUST WHERE YOU WANT THEM

Your XO French Door Combo Unit has the ability to store both wine at 41° to 64° F ready to serve and icy cold beverages from 34° to 50° F in the same compact system. Designed to fit undercounter and wherever your life takes you.

WORLD CLASS SERVICE | COMPREHENSIVE WARRANTIES

OUR LASTING COMMITMENT TO YOU

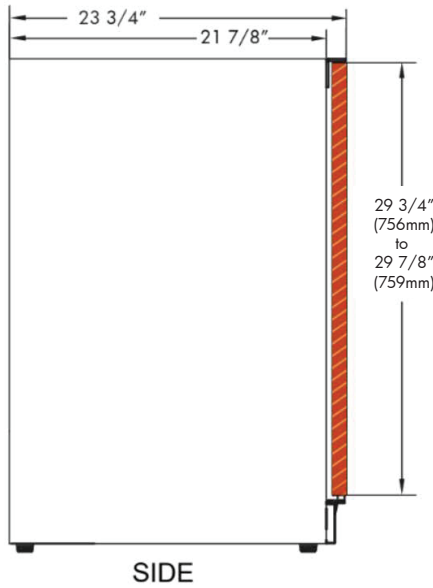
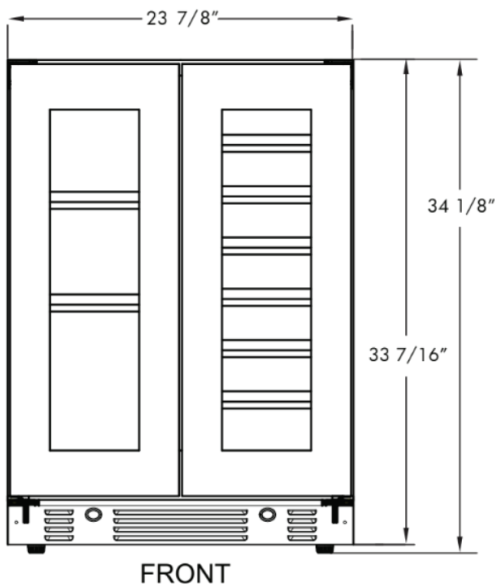

WHEN INSTALLING WITH THE HINGE SIDE NEXT TO A WALL, LEAVE ENOUGH CLEARANCE GAP FOR CABINET HANDLES. DOOR MUST BE ABLE TO OPEN A MINIMUM OF 90° FOR THE SHELVES AND RACKS TO EXTEND.

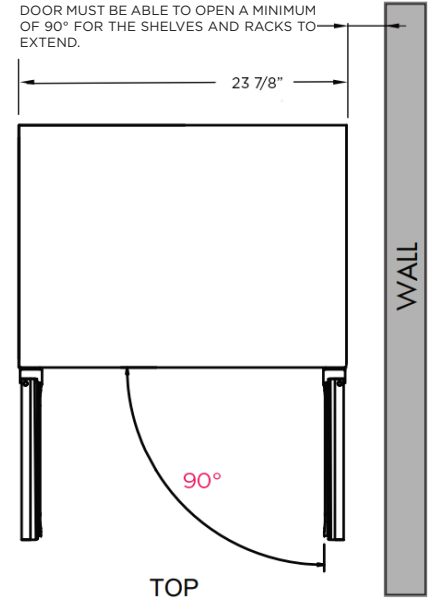

FEATURES

CAPACITY

Shelves and racks fully extend and hold:
(49) 12oz cans at 34° to 50° F
(21) 750ml Bordeaux bottles at 41° to 64° F

FEATURES

- Secure door lock
- Library quiet 39 dBA operation
- Elegant tri-color interior illumination
- Intuitive digital touch controls
- 6-1/2' Power Cord with low profile 90 flat plug
- Low E Glass blocks harmful UV light
- Alarm Functions
- Energy Saver and Sabbath Mode

SPECIFICATIONS

ELECTRICAL 120V 60HZ 4.35 AMP*

DIMENSIONS H 34 1/8"
W 23 7/8"
D 23 1/4"

ROUGH IN H 34 1/4" min
W 24"
D 24"

REFRIGERANT R600A

WEIGHT 149 lbs

PANEL DIMS

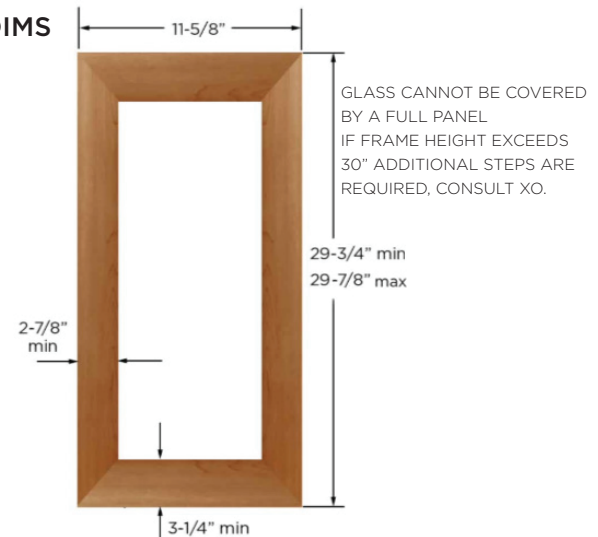

XO is exclusively distributed by EASTERN MARKETING CORP.
24 Eisenhower Parkway Roseland, NJ 07068

ROUGH IN DIMENSIONS

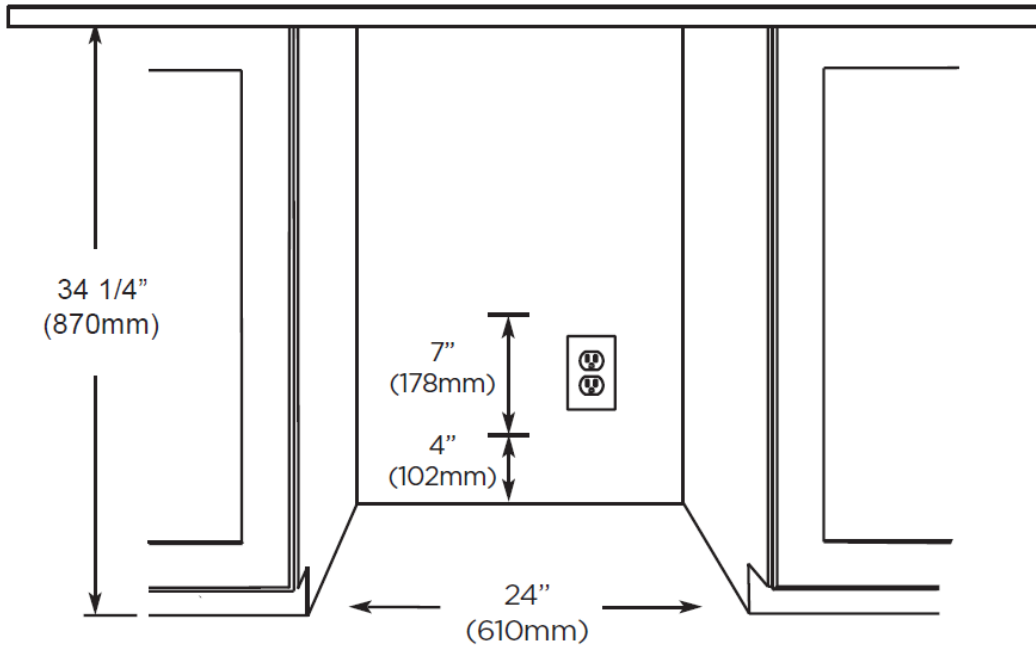

ALL XO UNDERCOUNTER
UNITS ARRIVE PRE-WIRED
WITH LOW PROFILE PLUGS
FOR EASY INSTALLATION



NEED MORE SPACE -
CUT INTO AN ADJOINING
CABINET TO REACH AN
OUTLET THERE

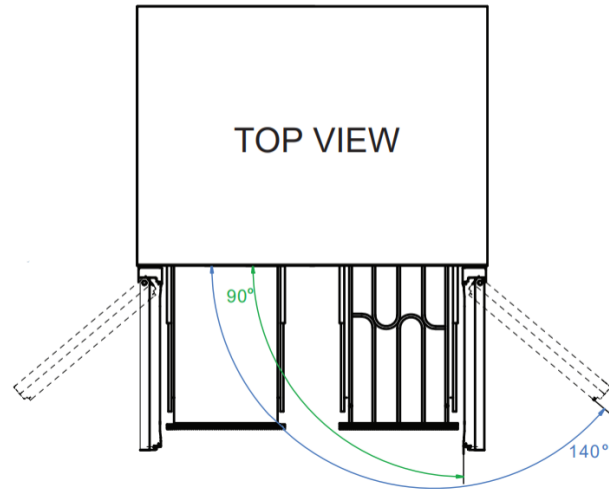
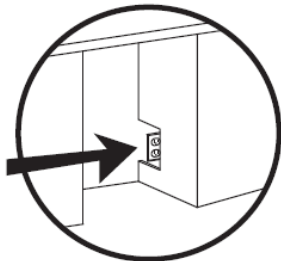

WHEN INSTALLING WITH THE HINGE
SIDE NEXT TO A WALL, LEAVE ENOUGH
CLEARANCE GAP FOR CABINET
HANDLES. DOOR MUST BE ABLE TO OPEN
A MINIMUM OF 90° FOR THE SHELVES
AND RACKS TO EXTEND.

CONSULT THE MANUAL FOR
INSTRUCTIONS ON CHANGING
THE DOOR STOP SETTING.