

## VW45G

### FEATURES

Breathe cleaner air and enjoy less greasy residue in your kitchen

Add a contemporary element with low-profile ventilation with glass that adds an artistic look

Adjust as needed with recessed controls that provide a sleeker look, yet maintain ultimate blower control

Matches the same heavy-duty stainless-steel construction, hand-finished hemmed edges, and welded seams of all Sub-Zero, Wolf, and Cove products

Select from internal, in-line, or remote blower options (blower required)

Lights your workspace with two LED light bars with two brightness settings

Reach ceiling heights with its telescoping chimney

Minimizes the backward flow of cold air with backdraft transition

### ACCESSORIES

Flue Extension

Make-Up Air Damper

Recirculating Filter

Recirculating Kit

Remote Control

Inline Blowers

Internal Blowers

Remote Blowers

Accessories available through an authorized dealer.

For local dealer information, visit [subzero-wolf.com/locator](http://subzero-wolf.com/locator).



### BLOWER OPTIONS

- 300 CFM Internal
- 600 CFM Internal
- 600 CFM Inline
- 600 CFM Remote

**PRODUCT SPECIFICATIONS**

Model	VW45G
Dimensions	45"W x 2 1/4"H x 19 1/4"D
Weight	62 lbs
Electrical Supply	110/120 VAC, 60 Hz
Electrical Service	15 amp dedicated circuit
Discharge Location	Vertical
Discharge Dimensions	6" Round
Bottom of Hood to Countertop	24" to 36"

**ELECTRICAL**

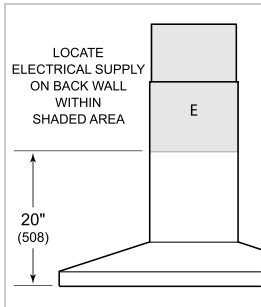

**NOTE:** Dimensions in parenthesis are in millimeters unless otherwise specified

**DIMENSIONS**

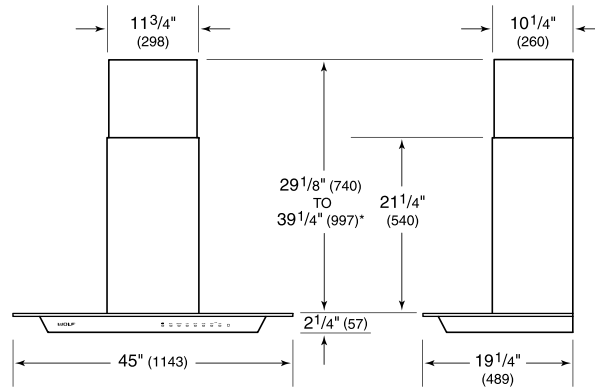

\*49 1/8" (1248) to 59 1/4" (1505) with accessory flue extension.