

RBMU36LX



Product family	Refrigerator
Installation	Built-in
Category	Bottom mount
Built-in niche	>200
No-frost system	Total
Cooling type	No-frost
Defrost	Automatic
Hinge	Door-to-door
Hinge position	Left
EAN code	8017709343477



Aesthetic

Aesthetics	Universal	Door shelf profile color	Silver
Color	Stainless steel	Drawers profile color	Silver
Material	Steel	Glass shelf profile color	Silver
Door stainless steel type	Normal	Display	TFT
Handle	Fixed	Display position	Internal
Logo color	Stainless steel	Water filter	Yes
Side material	Steel	Available colors	Steel
Logo	Applied		

Refrigerator compartment features



Number of compartments	2	Crisper cover	Yes
Compartment types	Low temperature compartment, Fruit and vegetable compartment	Type of crisper cover	Glass
No. of adjustable shelves	3	Low temperature compartment	Yes
Number of fruit and vegetables drawers	1	Refrigerator lighting	Yes
Type of adjustable shelves	Glass	Refrigerator lighting	LED
Crisper drawer type	Sliding crisper		

Refrigerator Inner Door

Number of adjustable door shelves	3	Adjustable door bins with wire support	Yes
--	---	---	-----

Other Refrigerator features



MultiFlow	Yes
------------------	-----

Freezer features

Number of drawers	1
--------------------------	---

Other Freezer features

Ice maker	Automatic	Ice-tray shelf	Yes
------------------	-----------	-----------------------	-----

Other technical features

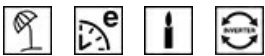

Display functions	Holiday, Fast-cooling, ECO, Temperature alarm, Showroom mode, Sabbath		
MultiZone	Yes		
Water network connection	Yes		
Power-on light	Yes		
Temperature alarm	Yes		
Door open alarm	Yes		
Temperature setting type	Electronic		
No. of compressors	2		
Refrigerant gas type	R600a		
Compressor type	Inverter		
Refrigerant quantity	3.8 oz		
Foam agent	HFO		

Performance / Energy Label

Annual energy consumption	580 kWh/year	Refrigerator compartment	15.01 cu. ft.
Total volume	15.01 cu. ft.	Total volume	20.52 cu. ft.
Freezer volume	4.63 cu. ft.		

Electrical Connection

Current	3,5 A	Power cord length	78 3/4 "
Voltage (V)	115 V	Plug	(B) NEMA 5-15P
Frequency (Hz)	60 Hz		

Logistic Information

Width	35 7/8 "	Built-in niche height	84 "
Built-in niche width	36 "	Width with doors open at 90°	41 1/4 "
Depth without handle	24 7/16 "	Product depth (handle included)	28 15/16 "
Built-in niche depth	25 "	Depth with door open at 90°	58 9/16 "
Height	83 7/16 "		

Also available

Installation kit code RSFZLK

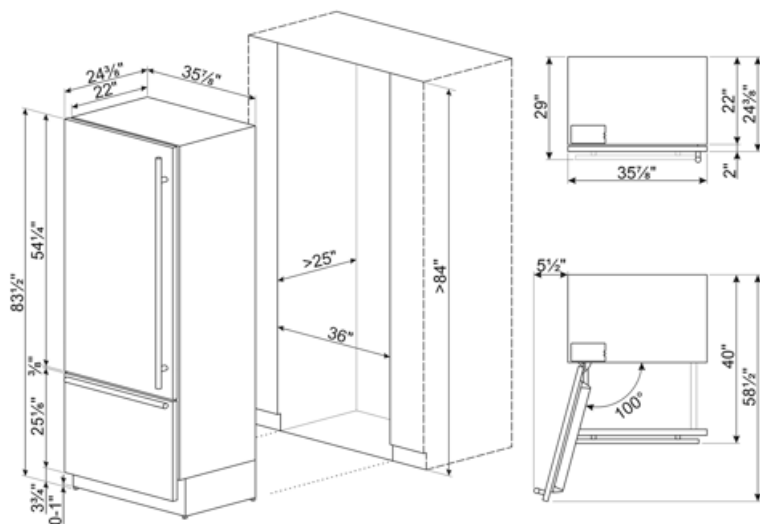







Compatible Accessories

RSFZLK



Symbols glossary

- | | | | |
|--|---|---|--|
|  | The automatic defrost system works by automatically defrosting at regular intervals eliminating the need to defrost altogether. |  | Economical mode: Analyzes fridge functioning during the activation and optimizes the operating cycle in order to reduce power consumption. |
|  | Power saving mode: The power saving mode allows you to disable the refrigerator and keep the freezer working. |  | LED interior lighting: is a more energy efficient and long lasting way of illuminating the interior of the appliance. |
|  | Inverter technology: The evolution of Smeg's driers towards more intelligent and environmentally sustainable models has led to the choice of using Inverter technology with heat pumps, which reduces significantly energy consumption. |  | Air plus: keeps food fresher for longer. |
|  | Sabbath: This function allows you to cook food during the Sabbath, the Holiday of rest in the Jewish religion, respecting the precepts. | | |