

# MWD24XU



<b>Product family</b>	Microwave oven
<b>Category</b>	Built-in
<b>Installation</b>	Under-cabinet
<b>Power source</b>	AC
<b>Cooking Method</b>	Microwave
<b>Oven controls</b>	Electronic



## Controls



<b>Display Controls</b>	1 LED Touch controls	<b>Opening</b>	Electrical button
-------------------------	-------------------------	----------------	-------------------

## Options



<b>Timer</b>	Electronic	<b>Child safety lock</b>	Yes
<b>End-of-cooking acoustic alarm</b>	Yes		

## Technical Features



<b>Cavity material</b>	SGCC painted	<b>Microwave door protection screen</b>	Yes
<b>No. of lights</b>	1	<b>Microwave stops when door is opened</b>	Yes
<b>Lighting</b>	Incandescent	<b>Inner cavity dimensions (HxWxD)</b>	439x424x200 mm
<b>Ceramic base</b>	Yes	<b>Microwave effective power</b>	1000 W
<b>Total no. of door glasses</b>	1		

## Electrical Connection

**Nominal power** 1500 W  
**Current** 14 A  
**Voltage** 120 V



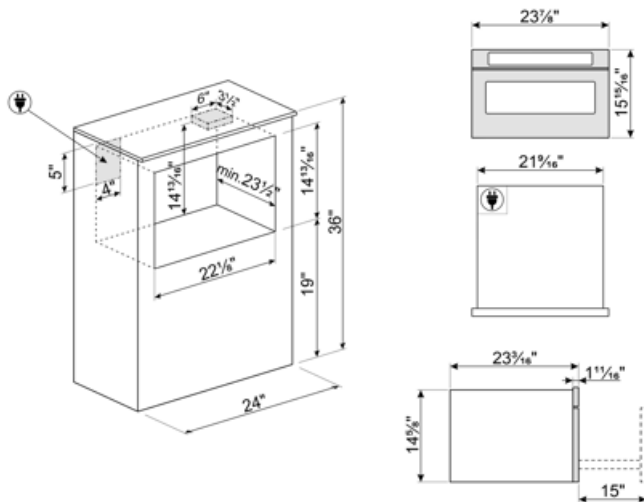



**Frequency** 60 Hz  
**Power cord length** 51 3/16 "



---

## Symbols glossary

---

- |  |   |   |  |
|--|---|---|--|
|  | Surfaceplus ceramic base: Surfaceplus ceramic base for a microwave oven - no turntable required, and the whole surface can be used for cooking. |  | Child lock: some models are fitted with a device to lock the programme/cycle so it cannot be accidentally changed.   |
|  | Microwave energy shortens cooking times dramatically and produces energy savings.   |  | Defrost by time: with this function the time of thawing of foods are determined automatically.   |
|  | Defrost by weight: With this function the defrosting time is determined   |  | Microwave: Penetrating straight into the food, microwaves cook very quickly and with considerable energy savings. Suitable for cooking without fat, they are also able to thaw and heat food without altering its original appearance and aroma. The microwave function can also be combined with conventional functions with all the resulting advantages. Ideal for all types of food. |
|  | Touch controls: Easy to use touch controls allow the appliance to be programmed at the touch of a button.                                       |   |  |