

# DW8220



Product family	Dishwashers
Commercial height	82 cm
Installation	Fully-integrated built-in
N° baskets	3, Flexi
EAN code	8017709354251



## Programs



Number of programs	10	Express 60°	Si
Washing temperatures	30, 50, 55, 70, 75 °F	Delicates	Yes
Express 27'	Yes	Normal	Yes
Automatic	Yes	Rinse	Yes
Intense	Yes	Eco express	Yes
Self Clean	Yes	Pots & Pans	Yes

## Options



Dry Assist+ option	Yes	FlexiZone half-load option	Yes
Delay start	Up to 24 hours	Special programs option	Yes

## Baskets



Basket color	Gray	Lower basket accessories	MultiLoad
Upper basket	1 foldable rack	Lower basket with anti-drip inserts	Yes
Upper basket height adjustment	On 3 levels	Colour Inner Components	Sage Leaf
Largest loadable dish in upper basket	25,0 inches	Cutlery basket	13 place settings
Lower basket	With 2 foldable racks		

## Technical Features



<b>Width</b>	23 9/16 "	<b>Turbidity sensor</b>	Yes
<b>Depth</b>	21 7/16 "	<b>Aquatest</b>	
<b>Display type</b>	LED display (3 digits)	<b>Flood protection system</b>	Single Aquastop
<b>Height</b>	32 3/16 "	<b>Max water hardness</b>	100°FH;58°dH
<b>Display</b>	Delay start, Program progress indicator	<b>Drying system</b>	Natural condenser drying, with Dry Assist + automatic door opening system at the end of the cycle
<b>On/off indicator</b>	Yes	<b>Min. and max. frontal panel weight</b>	4.4 - 24.3 lbs
<b>Salt indicator</b>	Light	<b>Min. and max plinth height</b>	50 - 215 mm
<b>Rinse aid indicator</b>	Light	<b>Adjustable feet</b>	2 3/4", from 32 1/4" to 35"
<b>Program progress indicator</b>	Yes	<b>Additional gaskets</b>	Yes
<b>End-of-cycle indicator</b>	Acoustic signal	<b>Back cover</b>	Yes
<b>Washing system</b>	Orbital		
<b>Third spray arm</b>	Single		
<b>Water softener</b>	With electronic setting		
		<b>Concealed heating element</b>	Yes
		<b>Filter</b>	Stainless steel
		<b>Tube material</b>	Stainless steel
		<b>Hinges</b>	Self-balancing, Sliding, FLEXIFIT

## Electrical Connection

<b>Connected power</b>	1100 W	<b>Connection type</b>	Single-phase
<b>Current</b>	13 A	<b>Power supply cable length</b>	140 "
<b>Voltage</b>	115 V		
<b>Frequency (Hz)</b>	60 Hz	<b>Plug</b>	(B) NEMA 5-15P

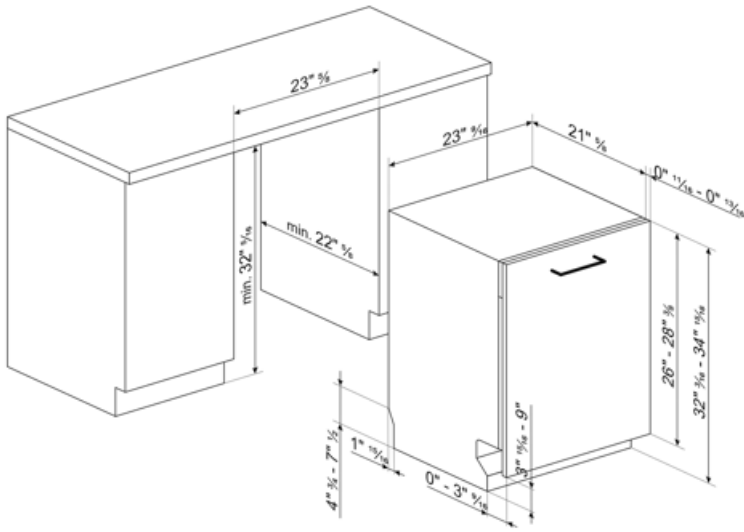

## Compatible Accessories



**KIT82SPRAN**



**KIT82SPRMW**

**KITFLEXI**



**KITJBDW**



**KITPL60B**

Toekick Kit in White colour with adjustable height and deepness. Can be installed over all the fully integrated and underbench models with variable fulcrum or flexifit hinges.



**KITPL60N**

Toekick Kit in Black colour with adjustable height and deepness. Can be installed over all the fully integrated and underbench models with variable fulcrum or flexifit hinges.



**KITPL60X**

Toekick Kit in Stainless Steel with adjustable height and deepness. Can be fitted over all the fully integrated and underbench models with variable fulcrum or flexifit hinges.

























**KITPLV2**

Kit extension for dishwasher and washing machine: lenght mt. 2



## Symbols glossary

	Acquastop: Some Smeg dishwashers are equipped with a simple Acquastop: float sensor in the bottom which is necessary to prevent an accidental leakage of water inside the appliance.		Aquatest measures the clarity of the water during an auto program, and automatically ensures the minimum consumption of water and energy.
	Anti-drip: Some models of dishwashers are equipped with special polymer nozzles anti-drip, that improve the process of drying.		COMM_HEIGHT_82_72dpi
	Delay Timer: The delay timer can postpone the start of the program by up to 24 hours.		Models with new Flexi Fit hinges are able to be installed in kitchens with a plinth of just 5cms. With this new hinge design, the panel has a sliding movement from the bottom to the top, avoiding any possible interference of the panel with the plinth.
	FlexiZone: The ½ load flexizone allows you to wash a reduced load saving energy, water and time and there are no restrictions on where the items are placed.		Inverter technology: The evolution of Smeg's driers towards more intelligent and environmentally sustainable models has led to the choice of using Inverter technology with heat pumps, which reduces significantly energy consumption.
	Noise Level: Excellent insulation and special devices keep noise to a minimum.		Orbital wash system distributes water evenly throughout the 60cm dishwasher cavity, directing water with precision to ensure an excellent wash.
	Auto 45°- 65°: The auto programme regulates the length of a cycle depending on the need for a pre-wash and the number of rinses required.		Delicate: Delicate washing program is designed for delicate dishes which are not heavily soiled.
	PRG_RINSE_72dpi		Rapid 27 Mins: The rapid 27 mins quick program takes just 27 minutes to wash a load.
	Ultraclean: The Ultraclean option performs a final rinse at a high temperature of 70°C eliminating virtually all bacteria.		The symbols show the number of plate settings of the dishwasher.
	System WaterSave ensures the best washing results with minimal water consumption depending on the model of dishwasher.		...
	...		...
	...		The Dry Assist + option, in addition to saving energy, ensures perfect drying of the dishes by opening the door automatically at the end of the wash c